











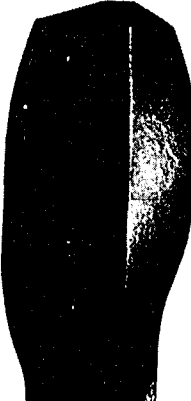



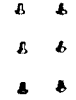











**SINGER**  
**210B6LG,7LG**









# SINGER\*









## PARTS LIST

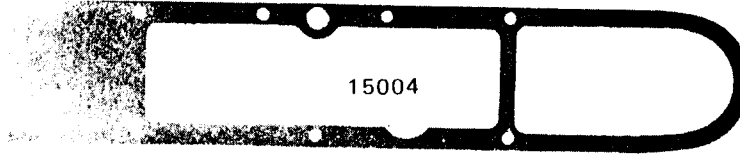
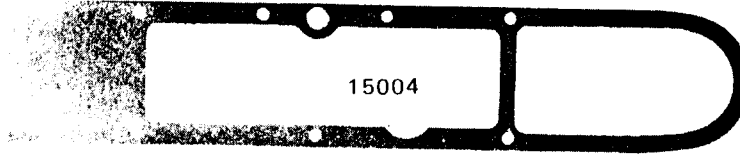







MODEL: 210B-6LG, 7LG







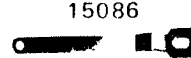



	1	2	3	4	5	6	7	8	9	10	11	12	13	14	15	
	<b>COVER PLATE, ARM SHAFT</b> カバー、上軸関係															
A																
B																
C																
D																
E																
F																
G																
H																
J																
K																

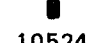
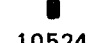
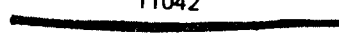





**15035**  **15038**  **15039**  **15037**  **15036**  **15039**  **15039**  **15039**  **15039**  **15039**  **15039**  **15039**  **15039**  **15039**  **15039**  **15039**  **15039**  **15039**  **15039**  **15039**  **15039**  **15039**  **15039**  **15039**  **15039**  **15039**  **15039** 



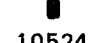
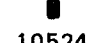

**15058**  **15059**  **15061**  **15057**  **8009**  **11006**  **13076**  **15038** 

**15703**  **11007**  **15004**  **20229**  **20223**  **20224**  **20225**  **20226**  **6031**  **11007**  **15007** 

**15034**  **11012**  **10725**  **10725**  **10597**  **11004**  **15086**  **8040**  **11142** 

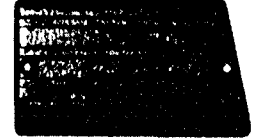
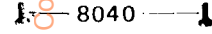
**10650**  **10551**  **10524**  **15013**  **11042**  **10563**  **10524**  **10725**  **10729**  **10571**  **13074**  **10568** 

**10524**  **15013**  **15026**  **10728**  **10522**  **10521**  **10506**  **15033** 

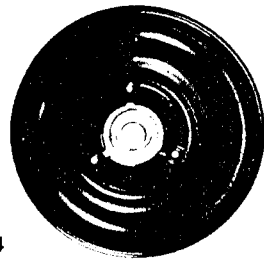
**15006**  **8040**  **10566**  **10576**  **10579**  **10504**  Standard type, 標準型 T 型

refer to spec.  
仕様別部品表参照

refer to spec.  
仕様別部品表参照

refer to spec.  
仕様別部品表参照

refer to spec.  
仕様別部品表参照

K  
L  
M  
N  
O  
P  
Q  
R  
S  
T  
U

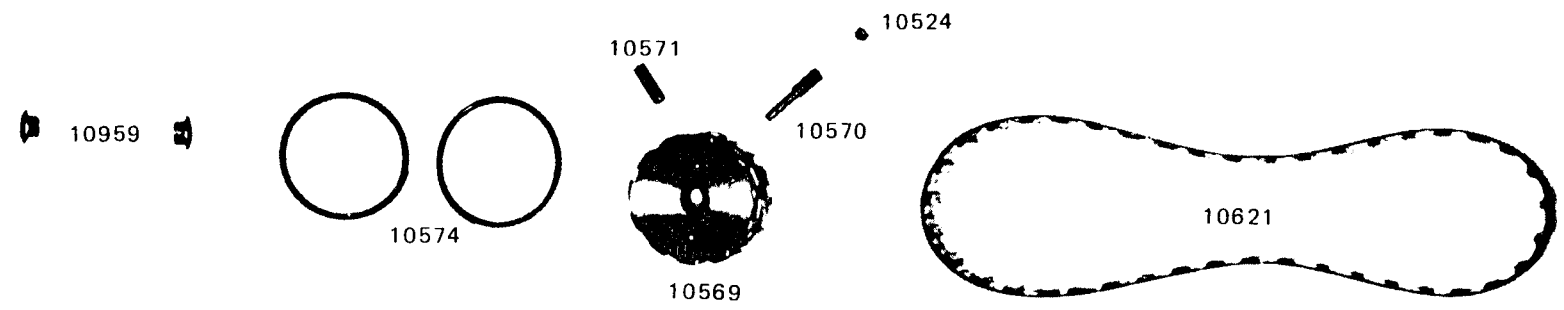
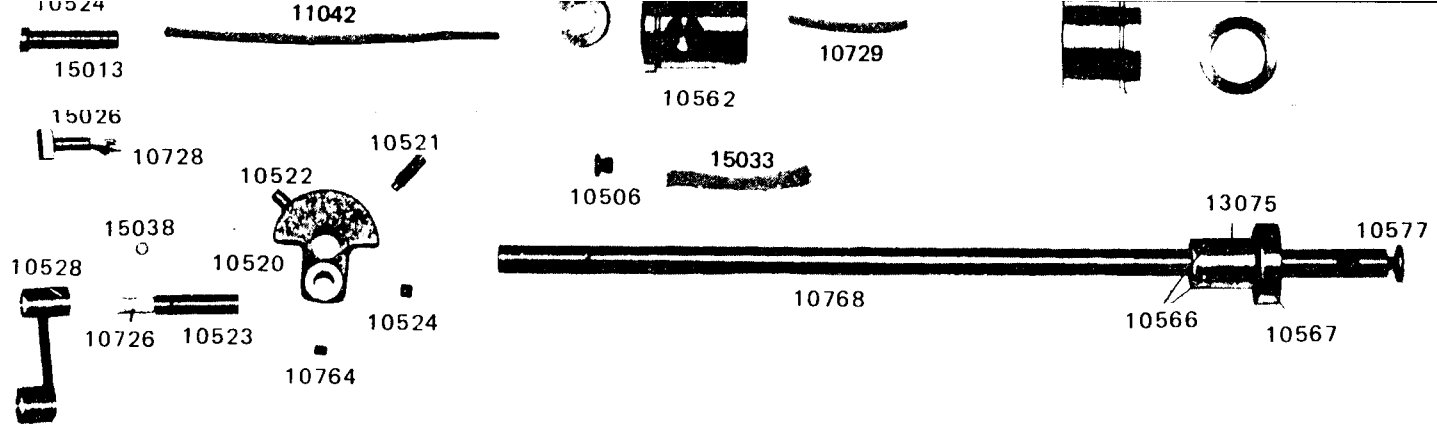

**THREAD GUIDE, TENSION, KNEE LIFTER LIFTING LEVER**  
糸掛, 調子板, 弓 關係

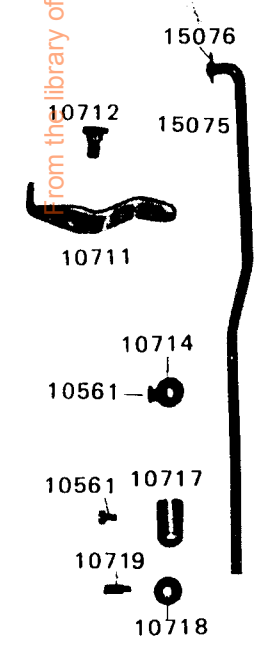
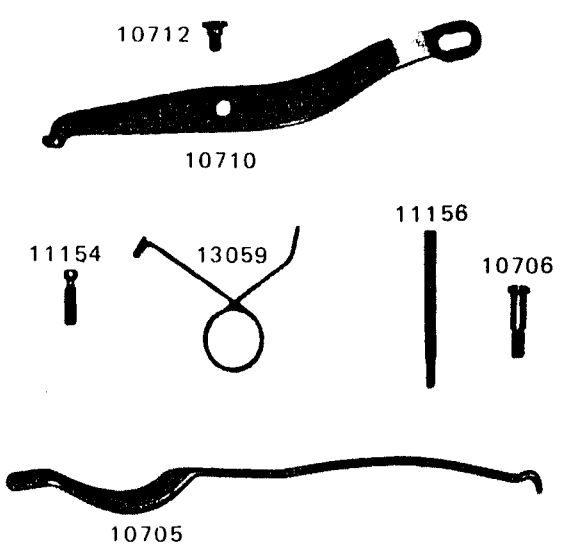
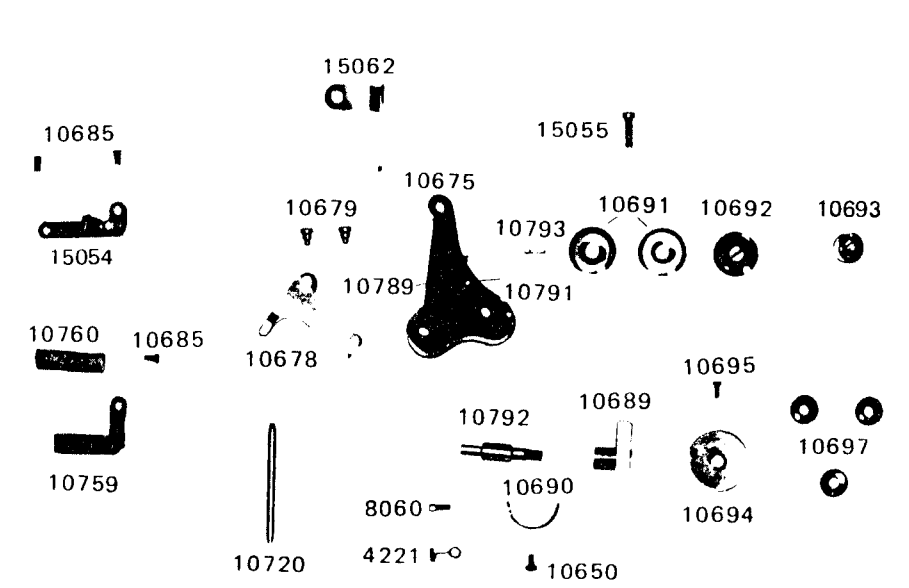

From the library of: Diamond Needle Corp

**NOTE! WHEN ORDERING PARTS, PREFIX ALL NUMBERS WITH CS, EXAMPLE CS \_\_\_\_\_**

1 2 3 4 5 6 7 8 9 10 11 12 13 14 15

**PRESSER BAR MECHANISM**

押え棒関係

**NEEDLE BAR MECHANISM**

針棒関係

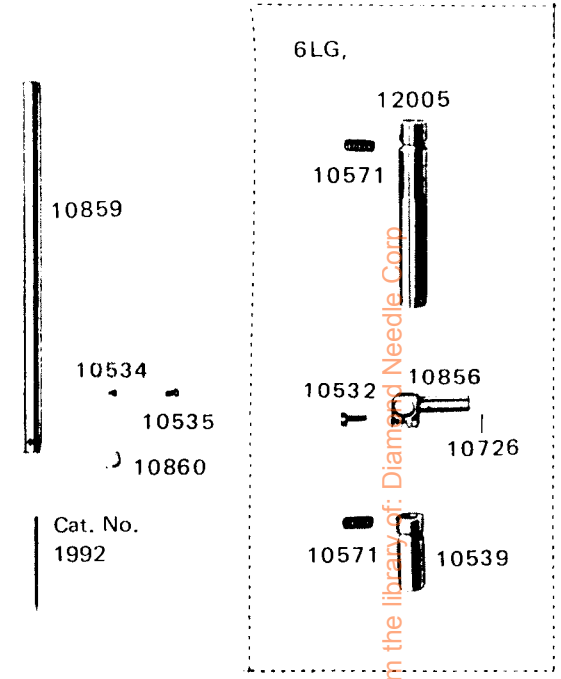
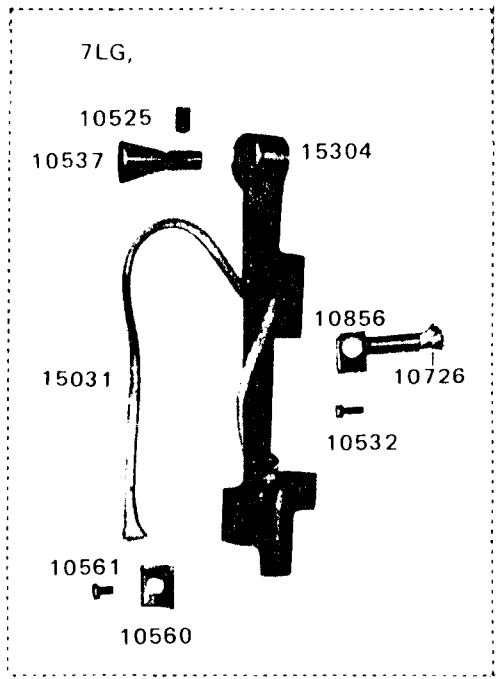
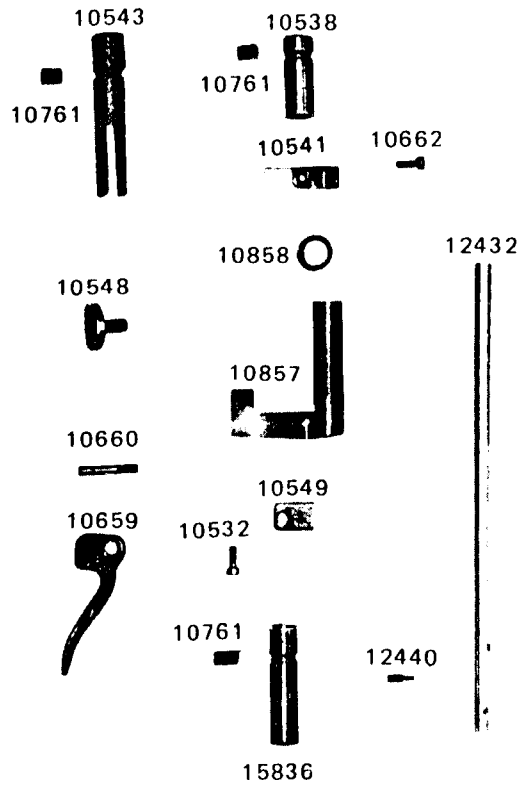

From the library of: Diamond Needle Corp.

Cat. No.  
1992

**OIL WICK FOR BED**

ベッド油芯関係

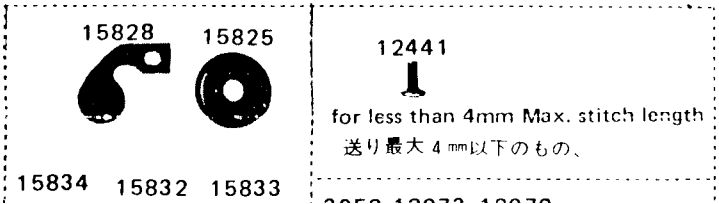
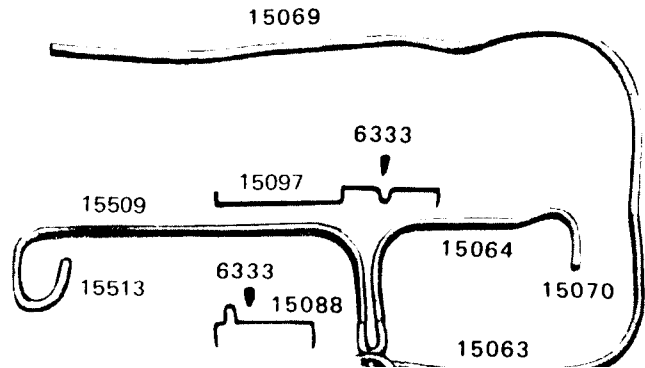

for less than 4mm Max. stitch length  
送り最大4mm以下のもの、

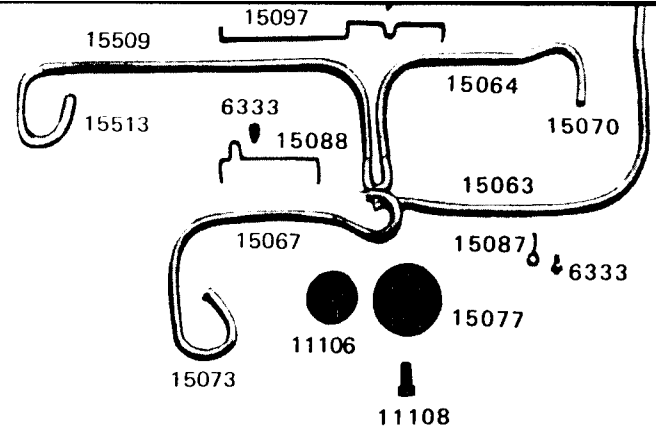
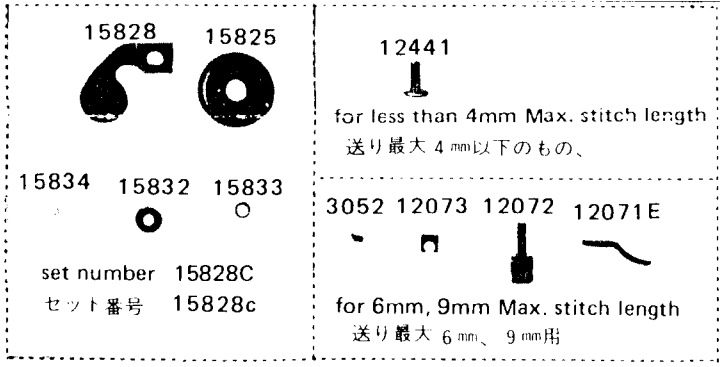

**SPECIFICATION FOR EACH MODEL 仕様別部品表**

Model 機種	Max. stitch length 送り最大 mm	bed slide ( left ) 角板 (左)	needle plate 針板	bed slide ( right ) 角板 (右)	thread take up lever 天秤	cover for thread take up lever 天秤カバー	feed driving eccentric adjusting disc うず巻カム	stitch length indicator 文字リング
6LG	4	10045	15749 6031	10061 10667 10668	15705	15258	10909	15709
	9	10045	15749	10061	18003	15025	10626	10505
7LG	2.5	10045	15712	10061	15705	15258	10883	15704
	3.5	10045	15712	10061	15705	15258	15746	15706
	6	10045	15748	10061	15702	15025	15510	10943

From the library of: Diamond Needle Corp

**NOTE! WHEN ORDERING PARTS, PREFIX ALL NUMBERS WITH CS, EXAMPLE CS \_\_\_\_\_**

1 2 3 4 5 6 7 8 9 10 11 12 13 14 15

LOWER SHAFT, FEED MECHANISM

送り機構, 下軸関係

A

B

C

D

E

F

G

H

J

K

L

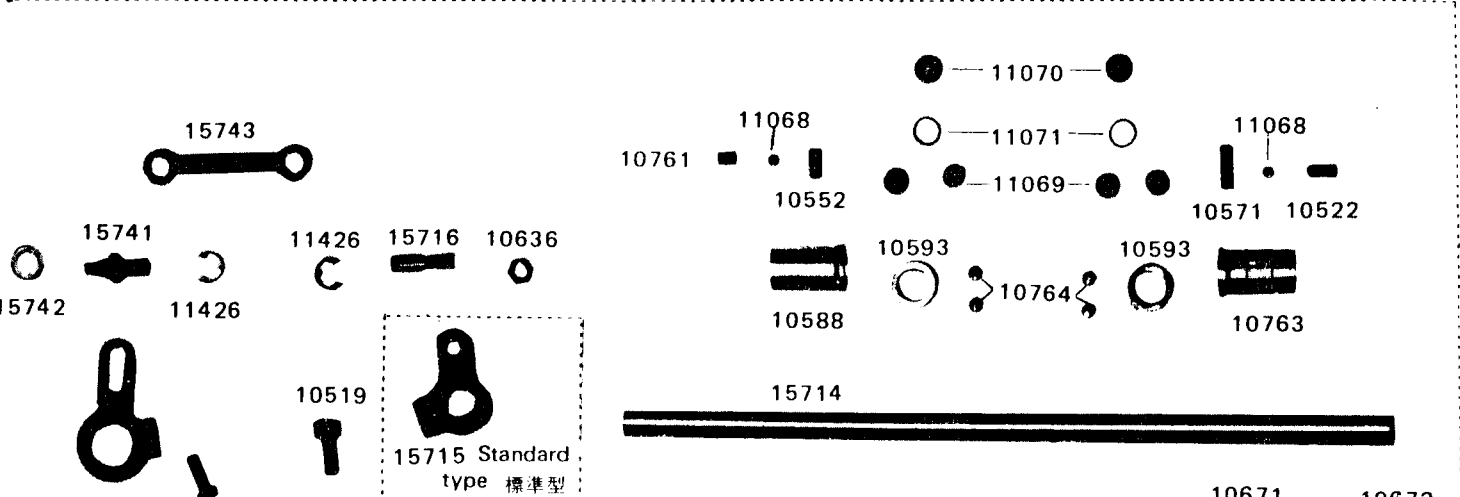
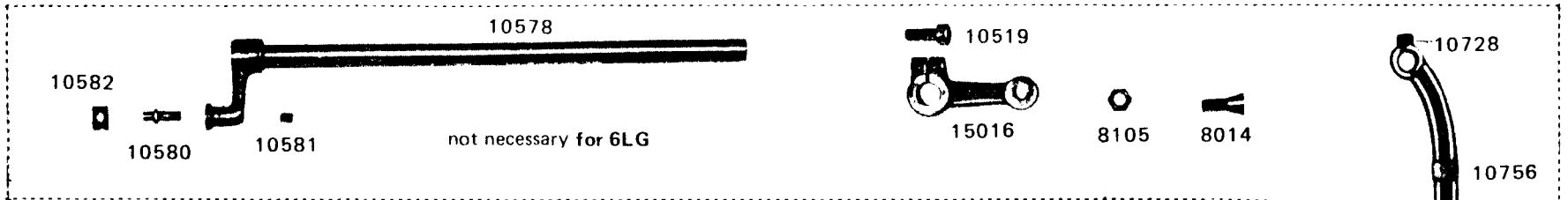

From the library of: Lock and Needle Co.

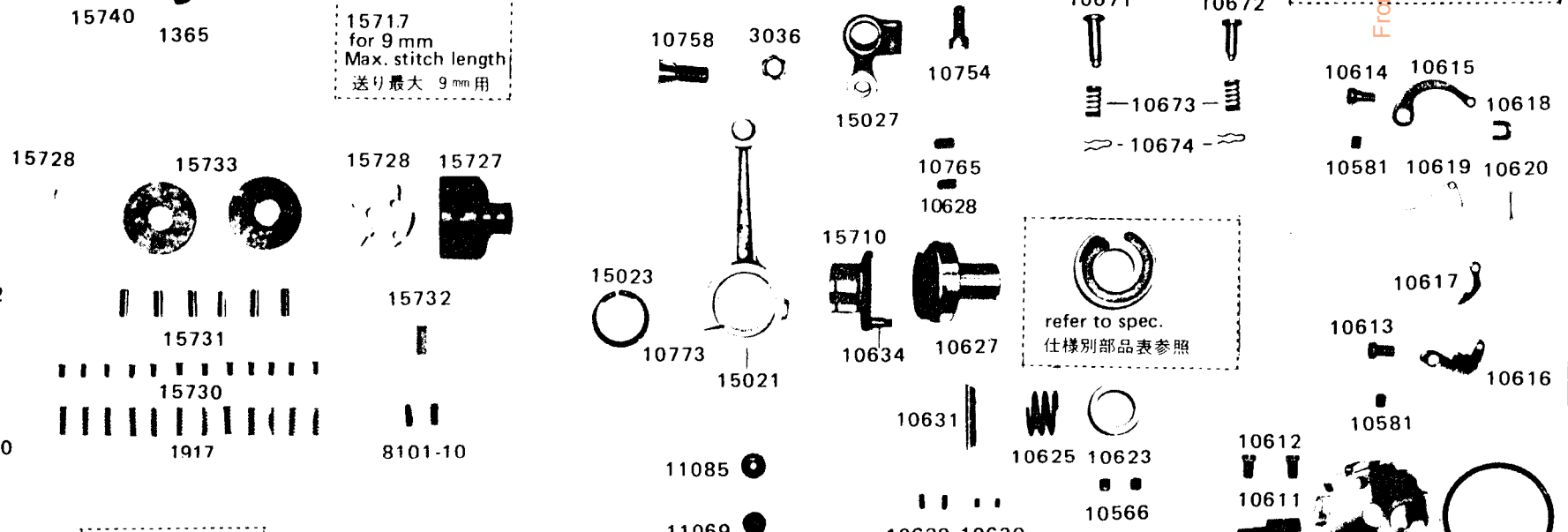

K  
L  
M  
N  
O  
P  
Q  
R  
S  
T  
U  
V

8101-10 15730 1917 8101-10

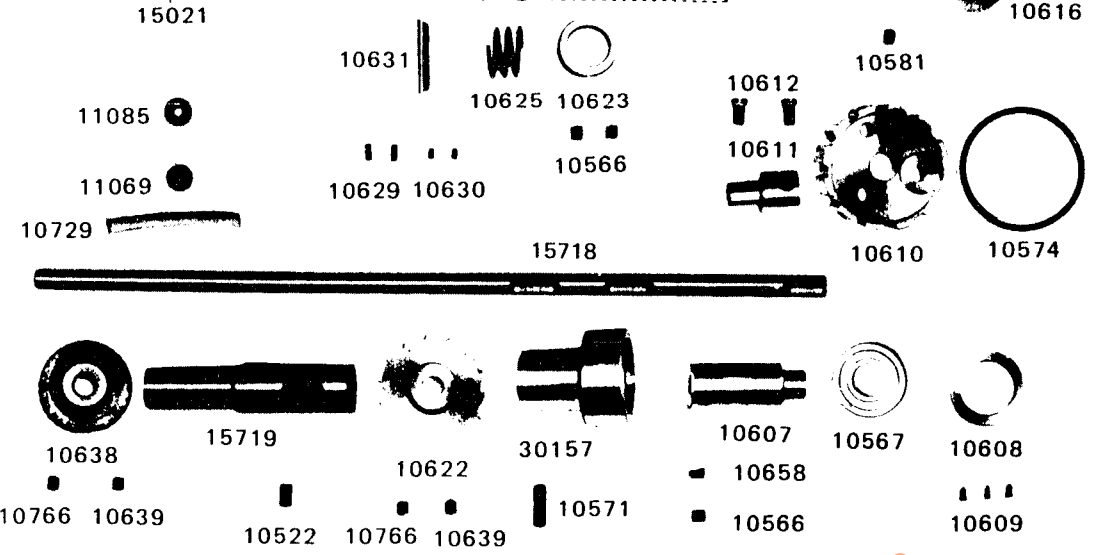
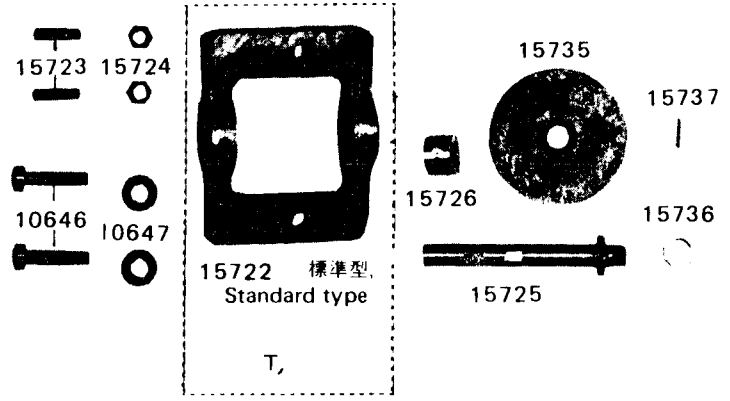

**HOOK MECHANISM カマ関係**

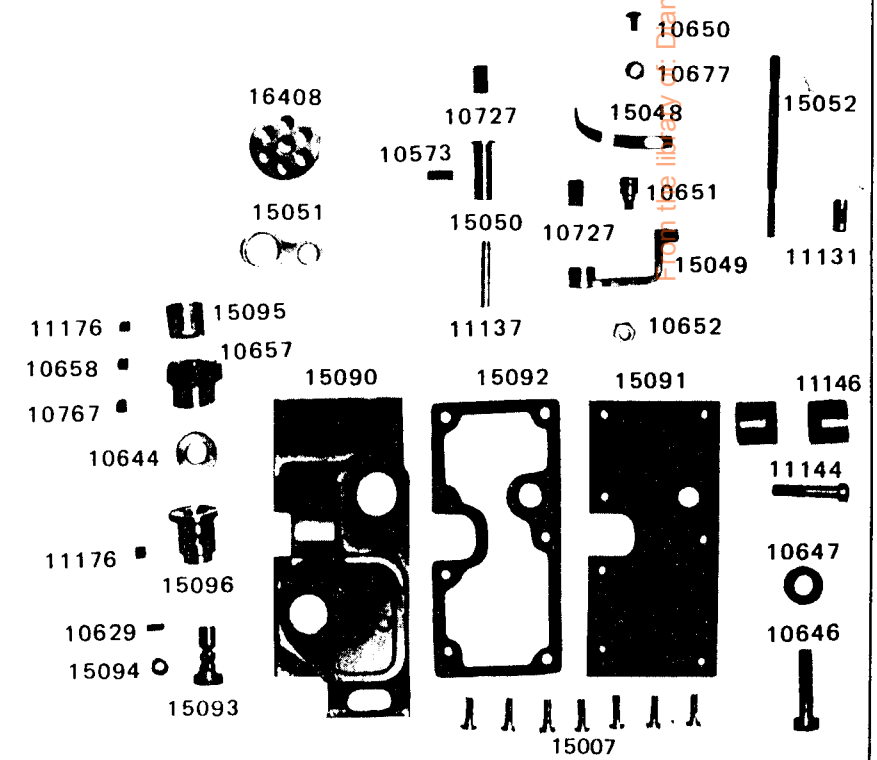
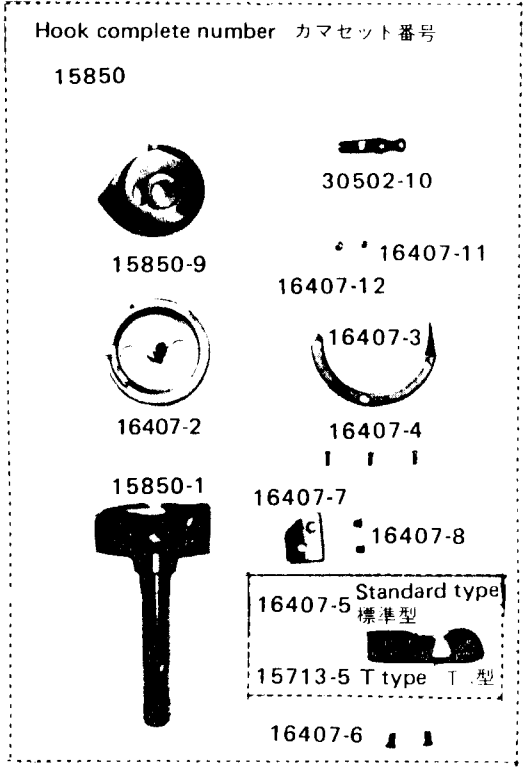

From the library of Diamond Needle Corp

NOTE! WHEN ORDERING PARTS, PREFIX ALL NUMBERS WITH CS, EXAMPLE CS \_\_\_\_\_

1 2 3 4 5 6 7 8 9 10 11 12 13 14 15

A

BELT GUARD (Optional Equipment) ベルトガード (別注品)

B

Belt Guard Complete 15098C

C

D

E

F

G

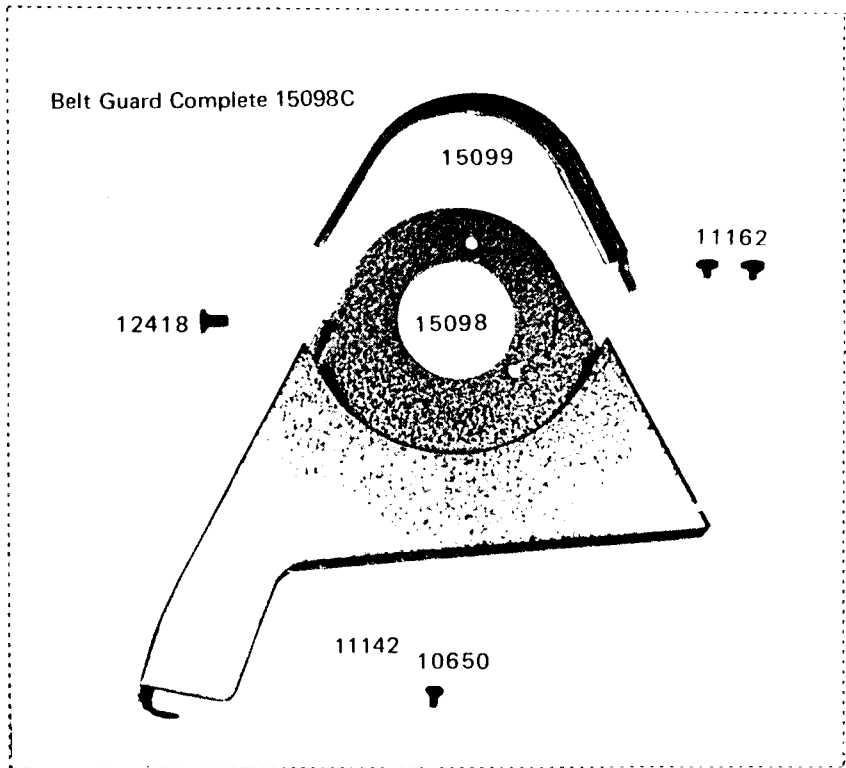

From the library of: Diamond Needle Corp

H

ACCESSORIES 付属品

J

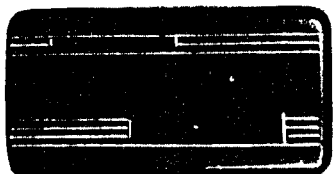

8132



16408

Cat. No 1992

K



15101

L



10748





L  
M  
N  
O  
P  
Q  
R  
S  
T  
U  
V



8118

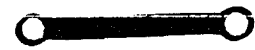

10748

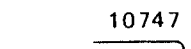

10747



6057



8125

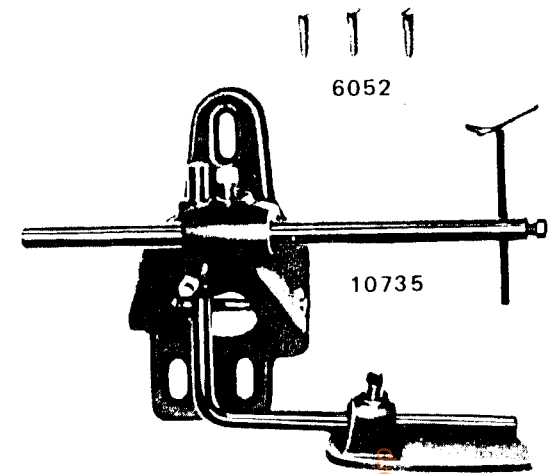

6052

10735

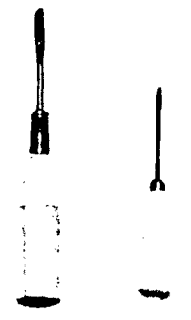

8120



8121

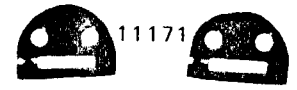

11171

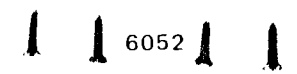

6052

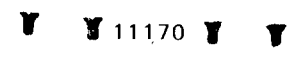

11170

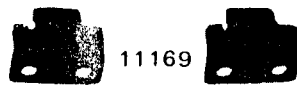

11169

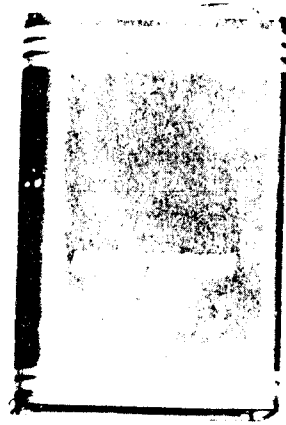

11193



15082

15081

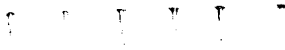

15080

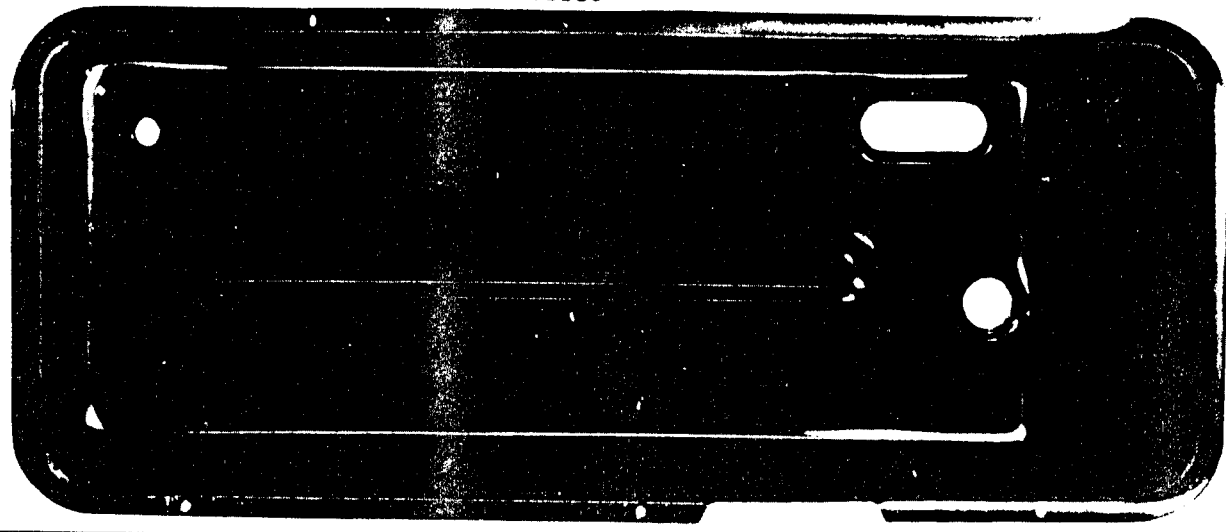

10780

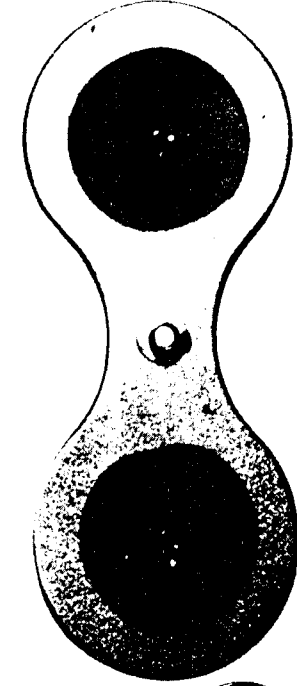

Eastman-Kodak Company Needle Co.

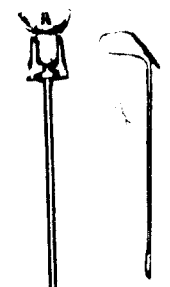

NOTE! WHEN ORDERING PARTS, PREFIX ALL NUMBERS WITH CS, EXAMPLE CS \_\_\_\_\_